



Professional Solutions - Unrivalled Value

Articulating arm holds screen 2.5" from wall and extends up to 21" for variable viewing angles. Multiple attachment points for different mounting surfaces offers additional safety. Smooth tilt adjustments of 15° forward and 5° back for a variety of viewing angles. Integrated cable management for clean look.

13"-42" / 33cm-106cm

80 LB / 36 KG

- **VESA Compatible**
Fits VESA hole patterns 75x75mm, 100x100mm, 200x100mm and 200x200mm.
- **Multiple Attachment Points**
Added safety with three attachment points for wood studs and four attachment points for concrete walls.
- **Extendable**
Extends from 2.5" to 21".
- **Screen Size**
Fits most 13" to 42" flat panel screens weighing up to 80lb (36kg).
- **Tilt**
Pre-tensioned tilt mechanism allows for smooth tilt adjustment of 15° forward and 5° back.
- **Cable Management**
Integrated cable management for clean look.
- **Included Hardware**
Pre-sorted hardware pack for easy component selection and installation (hardware for installation to wood studs or concrete surfaces included).

Functional Specifications

Depth from wall: 2.5" (63.5mm)
Swivel: 180° (3 joints)
Tilt: +15°/-5°

Mounting Surfaces: Wood stud, concrete & cinder block (with included hardware). Metal Stud (requires accessories).

Max Mounting Pattern:
200mm (7.9") width
200mm (7.9") height

Load Capacity: 80 LB / 36 KG
Warranty: Limited 10 Years

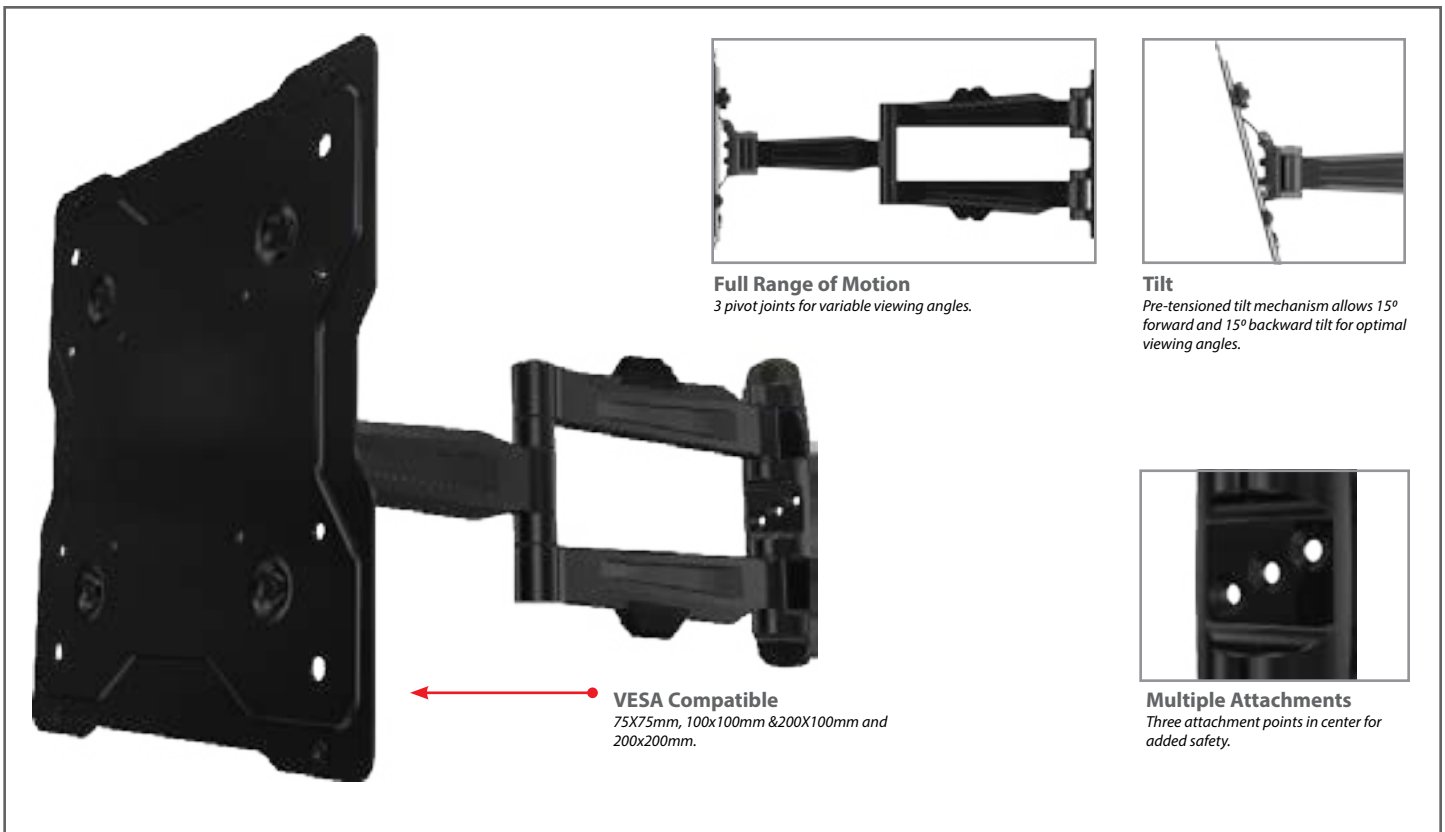



Full Motion Articulating Wall Mount

For 13" to 42" (33-106cm) LCD, LED and Plasma TV's

A40

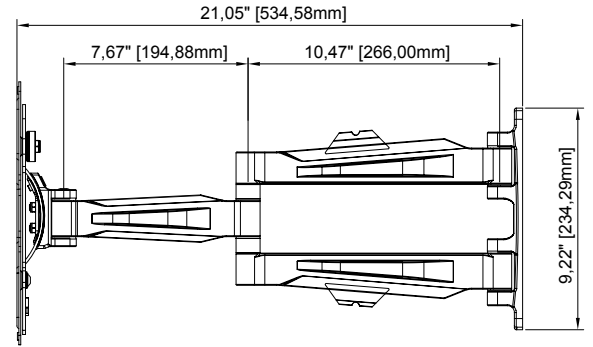
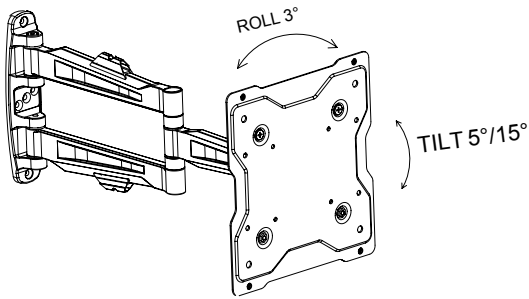
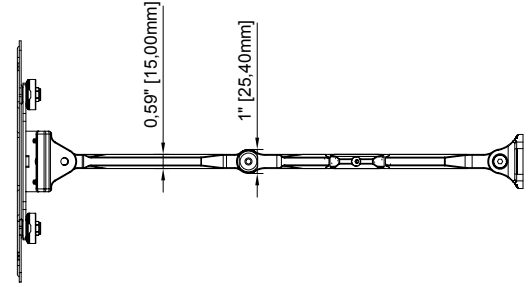
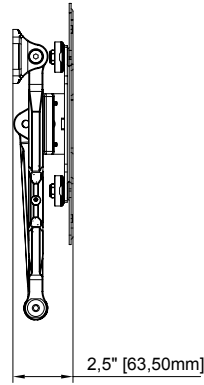
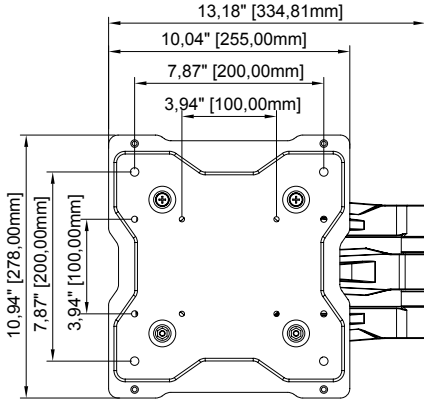

Product Specifications

Package Specifications

PRODUCT WEIGHT	LOAD CAPACITY	COLORS	FINISH	PACKAGE SIZE (WxHxD)	SHIP WEIGHT	UPC CODE	PACKAGE CONTENTS
9lb (4.1kg)	80lb (36kg)	Black	Scratch resistant powder coating	21" x 15.5" x 5.5" (533 x 394 x 140 mm)	12lb (5.4kg)	A40 (Black) 0815885013003	Mount, wall and screen mounting hardware, product manual.

Mounting Interface

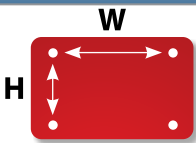

Max Mounting Pattern
200mm (W) x 200mm (H)

VESA	W	H	75mm	100mm	200mm	200mm
	X	X	X	X	X	X
	X	X	X	X	X	X

Accessories

Toggle bolts (for metal stud installation)



- HT2 - 2 Pack
- HT4 - 4 Pack
- HT6 - 6 Pack

Use when installing into metal stud.

On-wall Cable Management



- WA1 - 1 Shelf
- WA2 - 2 Shelves
- WA3 - 3 Shelves

Component shelf and on-wall cable routing system. Hides cables inside internal channels for a clean look.

Shelving



WF1 - 1 Shelf

Single-stud mountable component shelf.

Visit crimsonav.com to see the full line of vidamounts LCD/plasma, projector and TV/monitor mounts. © 2010 Crimson AV LLC. All rights reserved.